

This document is our property and shall not without our permission be altered, copied, used for manufacturing or communicated to any other person or company.

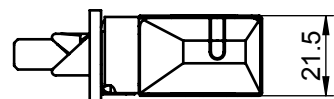
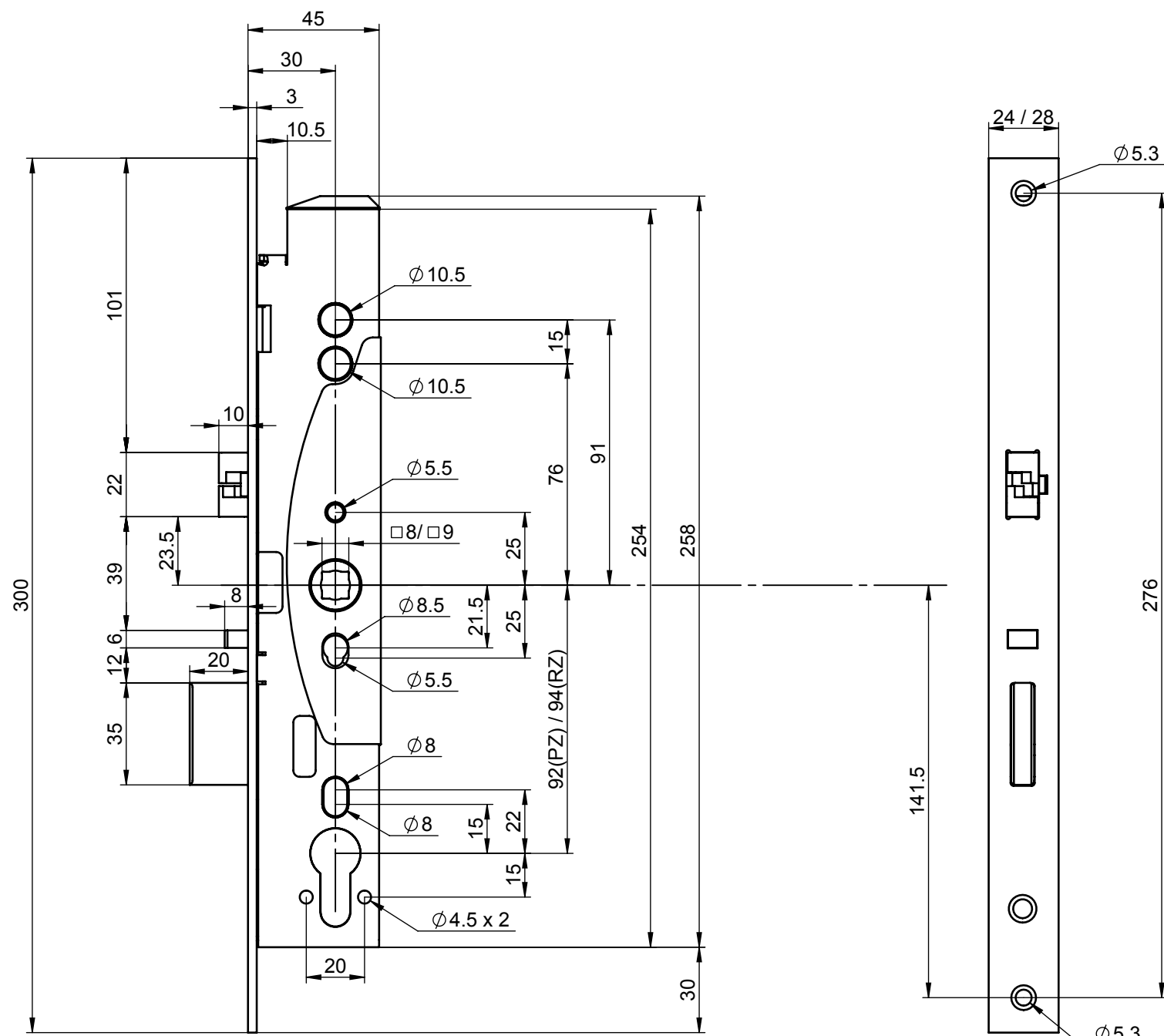

Surface: 456466			Material:			General tolerance: ISO 2768-mH		
Volume:	Weight:	Surface area:	created: 11.12.2014 JK	designed by:	changed by:	Scale: 1:2 (A3)	Projection: 	
 Abloy Oy An ASSA ABLOY Group brand			ABLOY EL461 / 30			Alternate ID		
			Document ID		Rev.: 1			

Part/assy:

Configuration:Default

SHEET 1 OF 1